

SWIMMING POOL PUMPS



DABPUMPS.COM.AU



DAB[®]
WATER • TECHNOLOGY



DAB pumps have been sold and serviced in Australia for over 30 years.



MADE BY PEOPLE FOR PEOPLE

DAB invests and believes in its workforce; in particular the contribution that each single person can give in terms of skills and know how. Each single employee of DAB is part of the company, each single employee of DAB is the company itself.

RESPONSIBILITY

We believe that the safeguard of the environment is possible not only through eco-friendly products, but most of all thanks to responsible individuals. This is why we try to come up with energy efficient products, working on projects with a low environmental impact and selecting partners and suppliers consistent with our ethics. DAB has also implemented green codes of conduct to increase the awareness within all those working at DAB of the importance of reducing waste and of respecting the environment, starting from the most trivial daily activities, both within and outside the company.



6 PRODUCTION PLANTS

ITALY:

DAB Mestrino
DAB Bientina
DAB Castello di Godego
DAB San Germano dei Berici

HUNGARY:

DAB Nagykanizsa

CHINA:

DAB Qingdao

12 SALES COMPANIES

DAB UK Colchester
DAB GERMANY Tonisvorst
DAB NETHERLANDS Drunen
DAB BELGIUM Groot Bijgaarden
DAB SPAIN Madrid
DAB RUSSIA Moscow
DAB SOUTH AFRICA Pretoria

DAB POLAND Warsaw
DAB USA Ladson
DAB MEXICO Mexico City
DAB CHINA Qingdao
DAB OCEANIA Melbourne, Australia



DAB AROUND THE WORLD



1 SALES OFFICE

DAB UAE Dubai

For over 40 years, DAB has been a main player in technologies for the movement and management of our most precious resource, water.

DAB offers technological solutions capable of ensuring reliability and efficiency, and to optimise energy consumption in domestic and residential, civil, agricultural and irrigation applications.

DAB AND SWIMMING POOLS



DAB's pumps for swimming pools are developed to guarantee reliability, efficiency and ease of maintenance. They are designed to offer added value for the installer and considerable savings, as well as comfort for the end user.

The pumps are suitable for all types of applications, from small residential swimming pools to public swimming pools.







The pump is the beating heart of the swimming pool since it moves the water for the purpose of filtration and treatment. A conventional pump, however, can be extremely expensive as it consumes more power than all the other devices combined. For this reason, **DAB** designed the highly energy-efficient **E.SWIM** electronic pump with low-consumption variable speed motor and hydraulics far superior to those of single-speed pumps.

E.SWIM is the ideal solution for keeping down energy costs: it requires up to 90% less power than a conventional pump at constant speed.



Energy Saving

up to 90% to any other traditional solution



Extremely Silent Running (45dba)

Thanks to water cooling technology



High Efficiency

thanks to the new brushless motor, new hydraulics and new electronic board



Display LCD

Easy to install and use with large LCD display



AWARDS AND CERTIFICATIONS

Award received at MCE 2016

Percorso **Efficienza**  **Innovazione**
oltre la classe A  2016



OVERVIEW

ENERGY SAVING

The new e.swim is the best solution to reduce energy consumption. A traditional single-speed pool pump consumes as much as 7 refrigerators, which means that it indirectly produces about 1,380,000 grams of CO₂, which is equivalent to what 138 trees would produce. E.SWIM really makes your system more efficient and optimises electricity costs.

It guarantees energy savings of up to 90% thanks to the combination of:

- Synchronous permanent magnet motor
- High efficient hydraulics to reduce pressure losses
- 8 settable speeds.

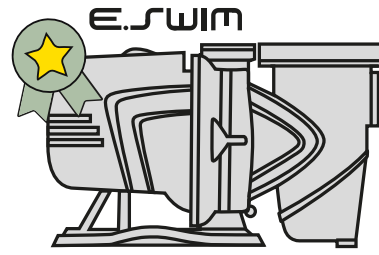

EXAMPLE WITH 3 CYCLES PER DAY, 10 HOURS A DAY AND 200 DAYS OF OPERATION PER YEAR

POOL SIZE	MODEL	E.SWIM	ENERGY COST \$/kWh	E.SWIM SAVING 1 DAY	E.SWIM SAVING 1 YEAR	E.SWIM SAVING 5 YEARS
30,000 Litres	0.5 Hp single speed	E.SWIM 150	0.27	\$0.88	\$175.50	\$877.50
			0.45	\$1.48	\$296.25	\$1,481.25
45,000 Litres	0.75 Hp single speed	E.SWIM 150	0.27	\$1.62	\$324.00	\$1,620.00
			0.45	\$2.70	\$540.00	\$2,700.00
60,000 Litres	1 Hp single speed	E.SWIM 150	0.27	\$2.00	\$400.50	\$2,002.50
			0.45	\$3.32	\$663.75	\$3,318.75
70,000 Litres	1.5 Hp single speed	E.SWIM 300	0.27	\$3.69	\$738.00	\$3,690.00
			0.45	\$6.15	\$1,230.00	\$6,150.00
90,000 Litres	2 Hp single speed	E.SWIM 300	0.27	\$3.65	\$729.00	\$3,645.00
			0.45	\$6.06	\$1,211.25	\$6,056.25
110,000 Litres	3 Hp single speed	E.SWIM 300	0.27	\$6.03	\$1,206.00	\$6,030.00
			0.45	\$10.05	\$2,010.00	\$10,050.00



SAFETY

FIRST

E.Swim with SVRS* software gives you full peace of mind: we have designed a system that disables the suction of the swimming pool pump, so that bodies or objects trapped against the suction port may be quickly released.



*E.Swim SVRS model available on request.

EASY INSTALLATION

The E.SWIM software allows you to operate not only at different speeds, but also at variable or constant flow rates, thus guaranteeing a unique user experience.

The intuitive interface gives access to the main settings depending on the specific application and all of the system information via the high resolution LCD screen.

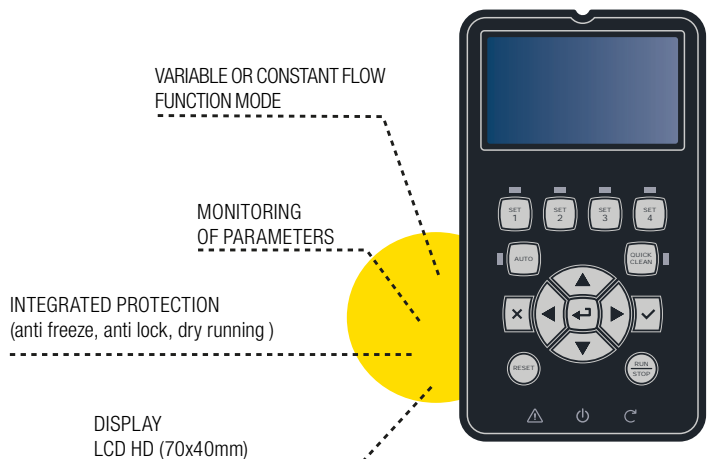

OVERVIEW

LOW NOISE

NO VIBRATIONS

Extreme silent running, thanks to the water cooled technology
 No vibration, no cooling fan, anti vibration feet. The special water cooled motor, the inverter and the anti vibration feet make e.swim the most silent swimming pool pump on the market.

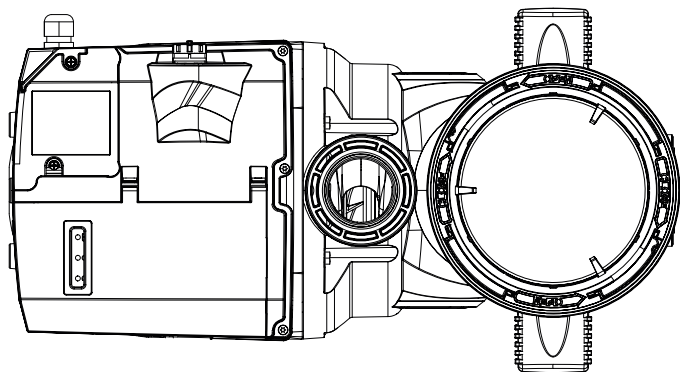
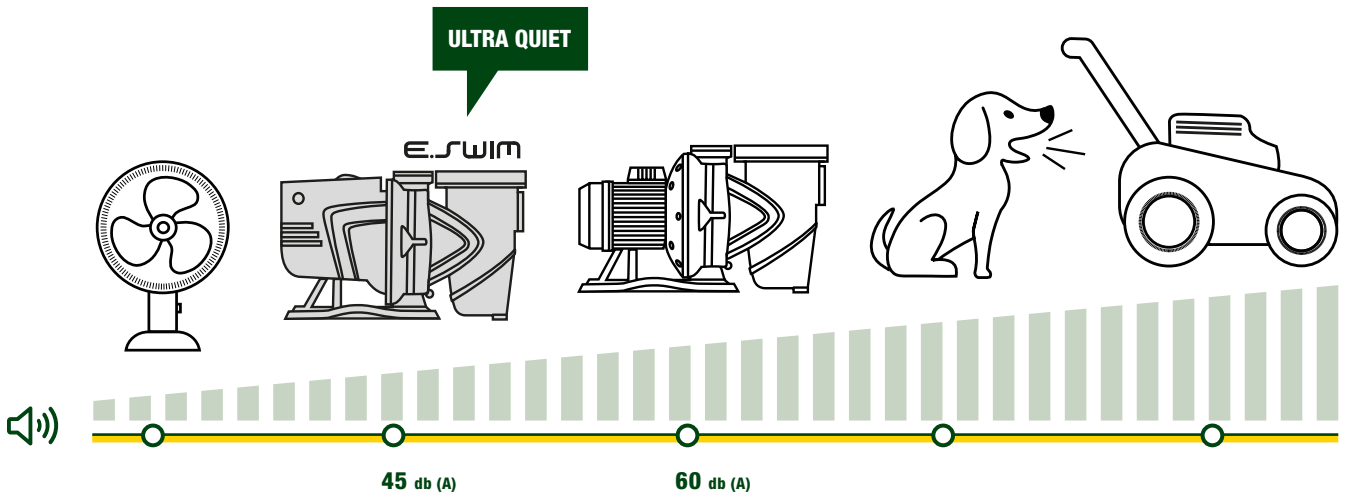

VERSATILITY

Wide choice and flexibility of use, manual or automatic operation, integrated control menu or connection from external control unit

MANUAL

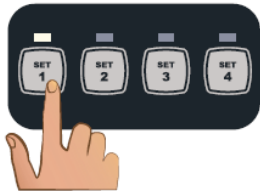

Set point pre-set with unlimited time or configurable with specified time. Editable via panel.

AUTO

Auto operation with daily and weekly timer scheduling of different speeds. Possibility to control the pump from REMOTE via digital or analogue contact (4-20mA / 0-10V)

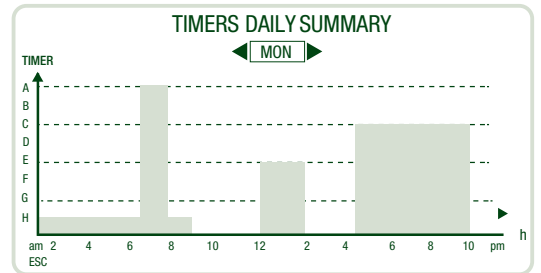

MINIMUM SPACE REQUIREMENT

MAXIMUM SPACE SAVING

The new structure and ergonomic design make for a compact product that can be installed anywhere. It occupies 30% less space than any other conventional system.

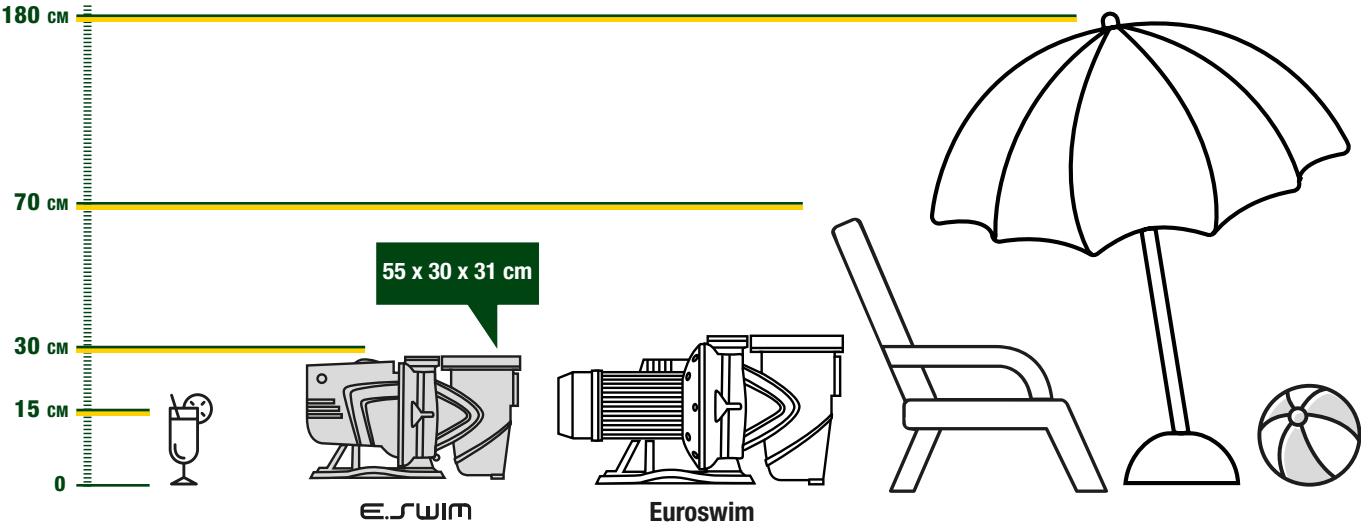

FEATURES



DESIGN

This innovative solution combines aesthetics with sturdy materials highly resistant to corrosion and oxidation.



INTEGRATED PREFILTER

The E.SWIM has a large canister, up to 5 litres, a transparent lid that can be removed without tools, and an internal filter easy to take out and clean.

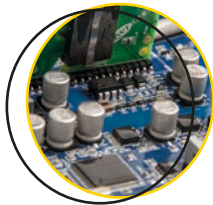

VARIABLE SPEED / FLOW CONTROL

The inverter control board allows operation at variable speed or flow rate, optimising performance and reducing consumption without the need for sensors.



SYNCHRONOUS MOTOR WITH PERMANENT MAGNETS

The new synchronous motor with permanent magnets represents a new benchmark on the market due to its efficiency and reliability.



HIGH EFFICIENCY HYDRAULICS

The impeller and volute are designed specifically to improve/optimize hydraulic performance.



WATER COOLING

Motor cooled by the pumped water, free from fan cooling. This lowers the noise and makes the pump more compact.



ANTI-VIBRATION FEET

The supporting base guarantees stability with integrated rubber feet that reduce vibrations.



USER INTERFACE PANEL

Intuitive interface panel for immediate control of the pump and programming according to any needs. High resolution LCD display.



Power cable and unions included with all pumps.

E.SWIM



Euroswim

HIGH RELIABILITY



Self-priming centrifugal high performance electric pumps with incorporated high capacity pre-filter. Completely watertight motor. Extremely silent and highly reliable, developed for the circulation and filtration of water in domestic and residential swimming pools.



Efficiency

high performance with low energy consumption

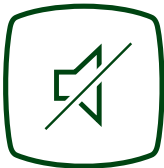

Very Quiet (60 DBA)

Silent running



Reliability

Corrosion resistant materials for a long life even at extreme conditions (+ 60° ambient temperature)

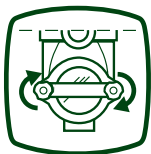

Simplicity

easy-to-open transparent cover for quick cleaning of the filter



MODEL	Flow at 10 m	
EUROSWIM 50	11 m ³ /h	183 l/pm
EUROSWIM 75	14 m ³ /h	233 l/pm
EUROSWIM 100	16 m ³ /h	266 l/pm
EUROSWIM 150	23 m ³ /h	383 l/pm
EUROSWIM 200	30 m ³ /h	500 l/pm
EUROSWIM 300	38 m ³ /h	633 l/pm

CERTIFICATIONS



FEATURES

DESIGN

This innovative solution combines aesthetics with sturdy materials highly resistant to corrosion and oxidation.

QUICK AND EASY CONNECTION

In & Out connection female, threaded 2".
Optional on request: special 3 piece adjustment 50/63 mm.

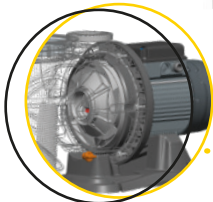

HYDRAULIC COMPONENTS

All components in contact with the liquid are made in polypropylene or noryl with glass fiber.
High efficiency Impeller with special design to cover and protect motor shaft against corrosion (motor is completely insulated)



LARGE PREFILTER

It has a large canister, up to 6 litres.
Motor (suitable up to 60°) a transparent lid that can be removed without tools, and an internal filter easy to take out and clean.

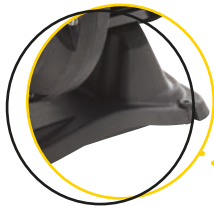

ANTI-VIBRATION FEET

The supporting base guarantees stability with integrated rubber feet that reduce vibrations.



MOTOR

All metallic components are surface treated.
Suitable for working in a high temperature environment (up to 50°C).
With exhaust condensate holes.
Capacitor is internal in the terminal board box.
Water proof bearings.



TERMINAL BOARD BOX

Easy and fast line connection,
Totally closed against the motor to avoid any accidental solid particle entry.

Power cable and unions included with all pumps.

Euroswim

SELECTION TABLE

PUMP SELECTION BASED ON POOL SIZE, FLOW REQUIREMENTS AND ACCESSORIES

	DIMENSIONS OF POOL (m)	VOLUME OF WATER (litres)	FLOW (litres per minute)	MODEL	
PRIVATE SWIMMING POOL	8 x 4	35,000 to 50,000	150	E.SWIM 150	EUROSWIM 50
	8x4 to 10x5	50,000 to 70,000	200	E.SWIM 150	EUROSWIM 75
	10x5 to 12x5	70,000 to 90,000	250	E.SWIM 150	EUROSWIM 75 EUROSWIM 100
	11x6 to 12x6	90,000 to 110,000	300	E.SWIM 150	EUROSWIM 100
POOL WITH IN-FLOOR CLEANING AND POOL/SPA JETS	8 x 4	35,000 to 50,000	150	E.SWIM 300	EUROSWIM 200
	8x4 to 10x5	50,000 to 70,000	200	E.SWIM 300	EUROSWIM 200
	10x5 to 12x5	70,000 to 90,000	250	E.SWIM 300	EUROSWIM 200 EUROSWIM 300
	11x6 to 12x6	90,000 to 110,000	300	E.SWIM 300	EUROSWIM 300
PUBLIC SWIMMING POOL	8 x 4	35,000 to 50,000	233	E.SWIM 150	EUROSWIM 75
	8x4 to 10x5	50,000 to 70,000	400	E.SWIM 300	EUROSWIM 200
	10x5 to 12x5	70,000 to 90,000	500	E.SWIM 300	EUROSWIM 200 EUROSWIM 300
	11x6 to 12x6	90,000 to 110,000	667	E.SWIM 300	EUROSWIM 300

*Times for complete recirculation of water within 6 hours for private pool and 2/3 hours for public pool

E.SWIM

E.SWIM 150

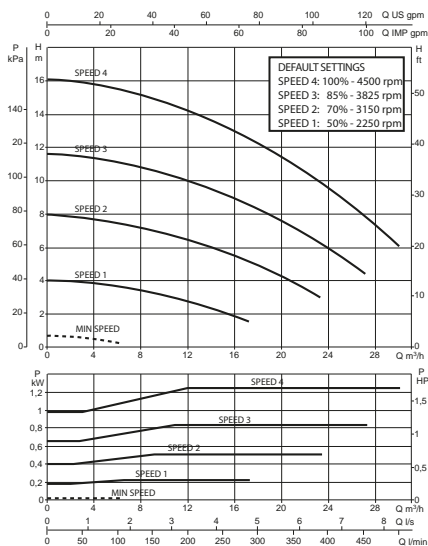

E.SWIM 300

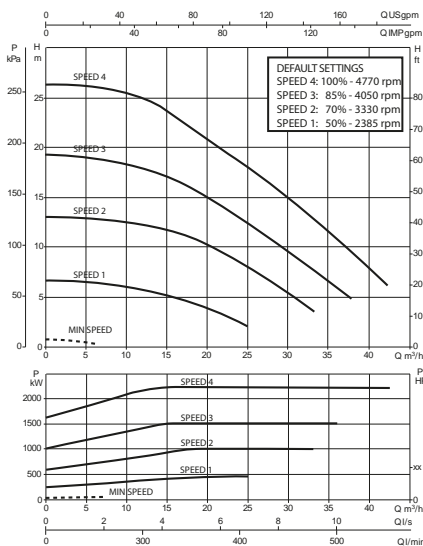

Euroswim

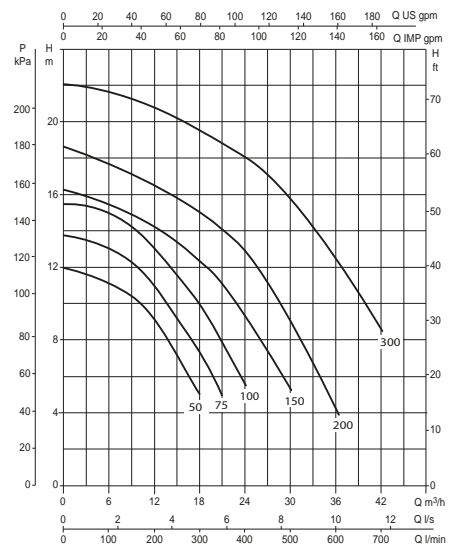



COMPARISON TABLE



E.SWIM



Euroswim

FEATURES	E.SWIM	Euroswim
HIGH EFFICIENCY HYDRAULICS		✓
HIGHLY RELIABLE AND DURABLE COMPONENTS	✓	✓
SMALL SIZE, FOR EASE OF INSTALLATION		✓
LCD DISPLAY	✓	✗
8 SPEEDS THAT CAN BE SET WITH TIMER	✓	✗
INTEGRATED DIAGNOSTICS FOR PROTECTION OF THE PUMP	✓	✗
DAB CONNECTIVITY	✓	✗
OPERATION AT VARIABLE SPEED	✓	✗
OPERATION AT VARIABLE FLOW RATE	✓	✗
OPERATION AT CONSTANT FLOW RATE	✓	✗
HIGH EFFICIENCY “BRUSHLESS” MOTORS WITH PERMANENT MAGNETS	✓	✗
WATER COOLING WITHOUT NEED FOR FAN	✓	✗
BACKWASHING MODE	✓	✗

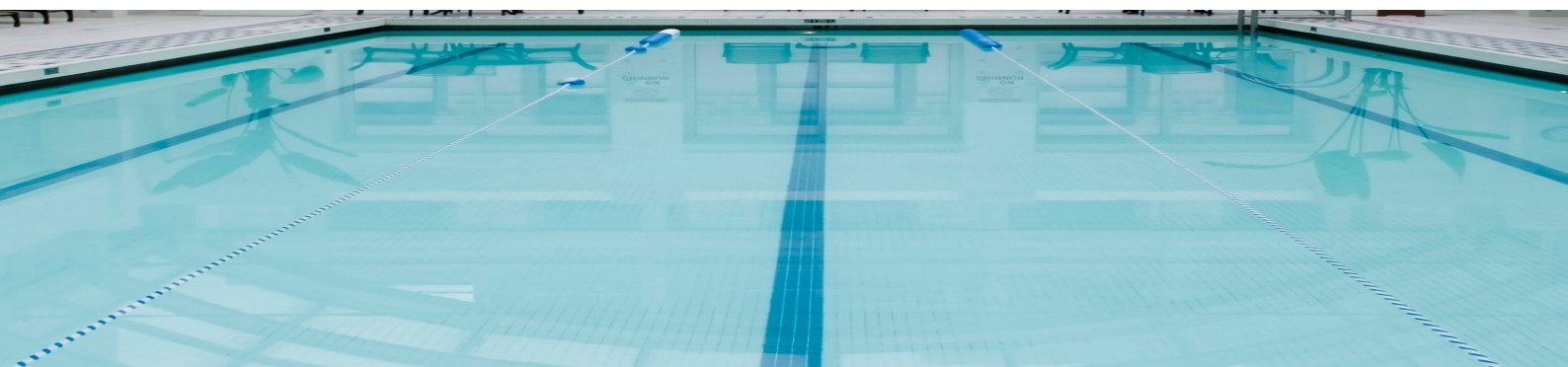

ACCESSORIES

DAB V-SERIES FILTER

TOP-MOUNT SAND FILTERS

DAB's V-Series fibre glass top-mount sand filters offer a UV resistant and durable construction. Easy to operate and ideal for use with any of DAB's pool pump range.



EUROCHLOR

SALT & MINERAL CHLORINATOR

Utilising energy efficient switch mode technology and low heat generation the Eurochlor salt & mineral chlorinator is the perfect addition to help keep your pool clean all year round.

FULL REMOTE CONTROL

REMOTE CONTROL FOR YOUR E.SWIM AND POOL SYSTEM

With the E.Swim Control Package you can control your pump and other parts of your pool system via a downloaded app.



A WIDE RANGE

EUROPRO HIGH FLOW

LARGE SWIMMING POOL FILTRATION

Self-priming, high-performance centrifugal pumps, with built-in large capacity prefilter. 2 or 4 pole motor completely isolated from the water. Extremely quiet and highly reliable, developed for the circulation and filtration in large swimming pool filtration systems. Also suitable for particular applications that require handling of seawater thanks to the mechanical seal made of AISI 316.



NKM-G / NKP G

LARGE SWIMMING POOL FILTRATION

The new range of prefilters gives the possibility of using the standardised monobloc centrifugal pumps of the NKM-G/NKP-G ranges, starting from DN 40 up to DN 150, for the circulation of water in large filtration systems.

JETCOM SP - EUROCOM SP

SWIMMING POOL WATER SUPPLY

Horizontal axis multistage centrifugal pump, characterised by extremely quiet operation. Useful for hydraulic pool cleaners and all applications involving the circulation of aggressive water; in general, containing chlorine.



UTILITY PUMPS

Utility pumps are multi-purpose pumps. Uses range from everyday applications around your swimming pool. Typical applications include, draining clear and waste water , salt water and to create water play areas or systems.

NOVA UP



VERTY NOVA



Submersible pumps in technopolymer are ideal for draining in residential environments subject to flooding or for portable applications such as emptying swimming pools, fountains and small excavations.

NOVA UP MAE

FEKA BVP



Submersible pumps ideal for draining and emptying in the residential sector. Suitable for pumping dirty water with solid particle sizes up to 50 mm.

FEKA VS



NOVA POND



Submersible pumps ideal for the recirculation of water in ponds and to create waterfalls and water features.

NOVA SW



Models specifically constructed to pump salt water.



MULTI 4 SW



**DAB PUMPS S.p.A**

Via Marco Polo, 14
35035 Mestrino (PD), Italy
sales@dwtgroup.com
Tel. +39 049 512 5000
Fax +39 049 512 5950

**DAB PUMPS LTD.**

6 Gilbert Court
Newcomen Way
Severalls Business Park
Colchester
Essex
CO4 9WN - UK
salesuk@dwtgroup.com
Tel. +44 0333 777 5010

**DAB PUMPS B.V.**

't Hofveld 6 C1
1702 Groot-Bijgaarden - Belgium
info.belgium@dwtgroup.com
Tel. +32 2 4668353

**DAB PUMPS B.V.**

Albert Einsteinweg, 4
5151 DL Drunen - Nederland
info.netherlands@dwtgroup.com
Tel. +31 416 387280
Fax +31 416 387299

**DAB PUMPS GMBH**

Am Nordpark 3
D - 41069 Mönchengladbach - Germany
info.germany@dwtgroup.com
Tel. +49 2161 47388-0
Fax +49 2161 47388-36

**DAB PUMPS IBERICA S.L.**

Calle Verano 18-20-22
28850 - Torrejón de Ardoz - Madrid
Spain
Info.spain@dwtgroup.com
Tel. +34 91 6569545
Fax: + 34 91 6569676

**DAB PUMPS HUNGARY KFT.**

H-8800
Nagykanizsa, Buda Ernő u.5
Hungary
Tel. +36 93501700

**DAB PUMPS POLAND Sp. z o.o.**

Ul. Janka Muzykanta 60
02-188 Warszawa - Poland
polska@dabpumps.com.pl
Tel. +48 223 816 085

**OOO DAB PUMPS**

Novgorodskaya str. 1, block G
office 308, 127247, Moscow - Russia
info.russia@dwtgroup.com
Tel. +7 495 122 0035
Fax +7 495 122 0036

**DAB PUMPS INC.**

3226 Benchmark Drive
Ladson, SC 29456 - USA
info.usa@dwtgroup.com
Tel. 1- 843-797-5002
Fax 1-843-797-3366

**DAB PUMPS SOUTH AFRICA PTY**

Twenty One industrial Estate,
16 Purlin Street, Warehouse 4, Unit B
Olifantsfontein - South - Africa
info.sa@dwtgroup.com
Tel. +27 12 361 3997

**DAB PUMPS (QINGDAO) CO. LTD.**

No.40 Kaituo Road, Qingdao Economic & Technological
Development Zone
Qingdao City, Shandong Province - China
PC: 266500
sales.cn@dwtgroup.com
Tel. +86 400 186 8280
Fax +86 53286812210

**DAB PUMPS DE MÉXICO, S.A. DE C.V.**

Av Amsterdam 101 Local 4
Col. Hipódromo Condasa,
Del. Cuauhtémoc CP 06170
Ciudad de México
Tel. +52 55 6719 0493

**DAB PUMPS OCEANIA PTY LTD**

426 South Gippsland Hwy,
Dandenong South VIC 3175 - Australia
info.oceania@dwtgroup.com
Tel. +61 1300 378 677



426 South Gippsland Hwy, Dandenong South VIC 3175
dabpumps.com.au

Phone +61 1300 DPUMPS
+61 1300 378 677